

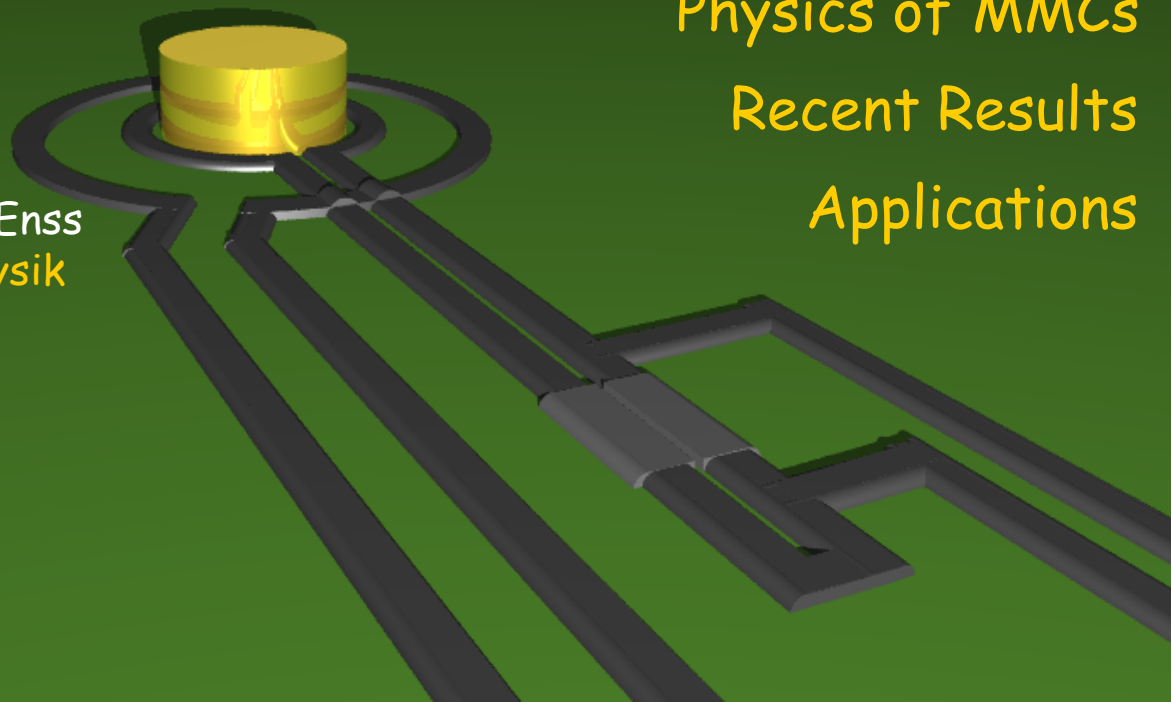

# Metallic Magnetic Calorimeters: Detectors for High Resolution X-Ray Spectroscopy

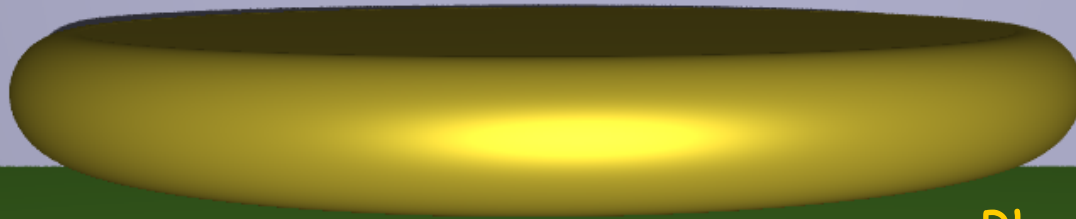

A. Fleischmann,  
T. Daniyarov, M. Linck  
H. Rotzinger, A. Burck, C. Enss  
Kirchhoff-Institut für Physik  
Universität Heidelberg

G.M. Seidel  
Department of Physics  
Brown University

Physics of MMCs  
Recent Results  
Applications

# Metallic Magnetic Calorimeter

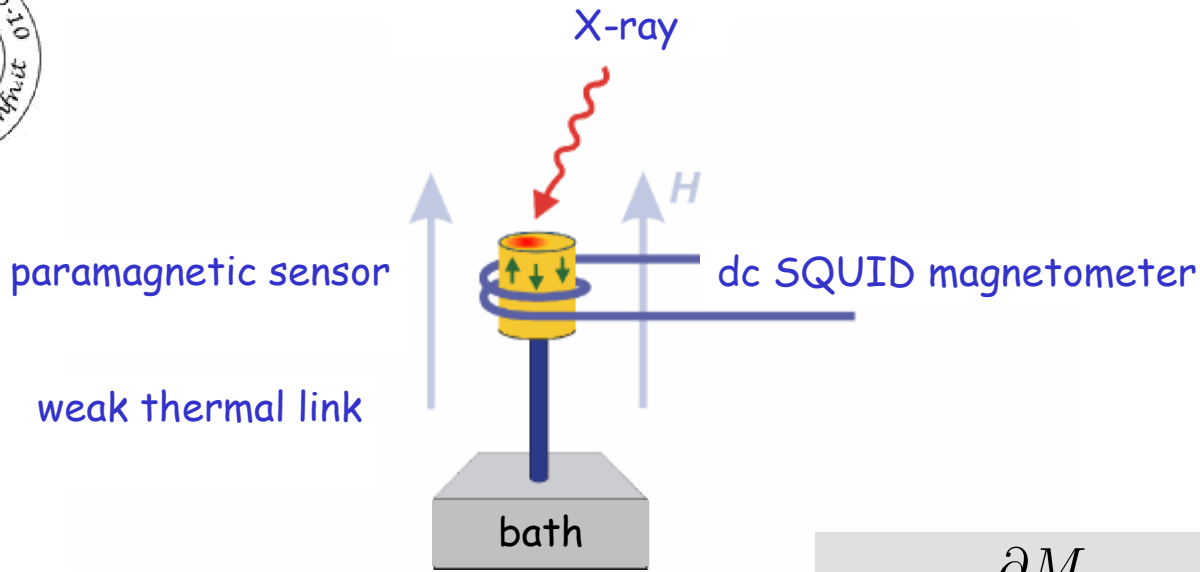

$$\delta M = \frac{\partial M}{\partial T} \delta T = \frac{\partial M}{\partial T} \frac{E_\gamma}{C_{\text{tot}}}$$

Sensor: Au:Er ←

Ag:Er

Bi<sub>2</sub>Te<sub>3</sub>:Er

PbTe:Er

# Magnetism of Sensor Material: Au:Er

gold (fcc)

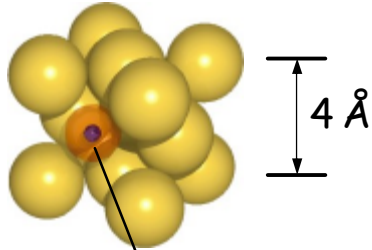

4f - electrons (Er)

## Rare earth ions in metals

- 4f - shell partially filled



angular momentum & magnetic moment

$\text{Er}^{3+}$ :  $J = 15/2 \rightarrow 16$  levels

- crystal field splitting

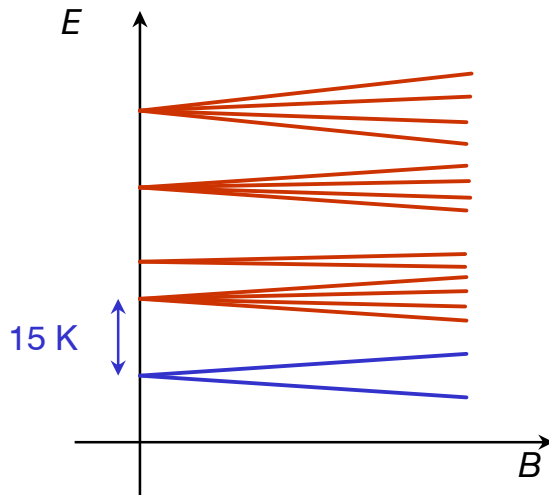

# Magnetic Susceptibility of Au:Er

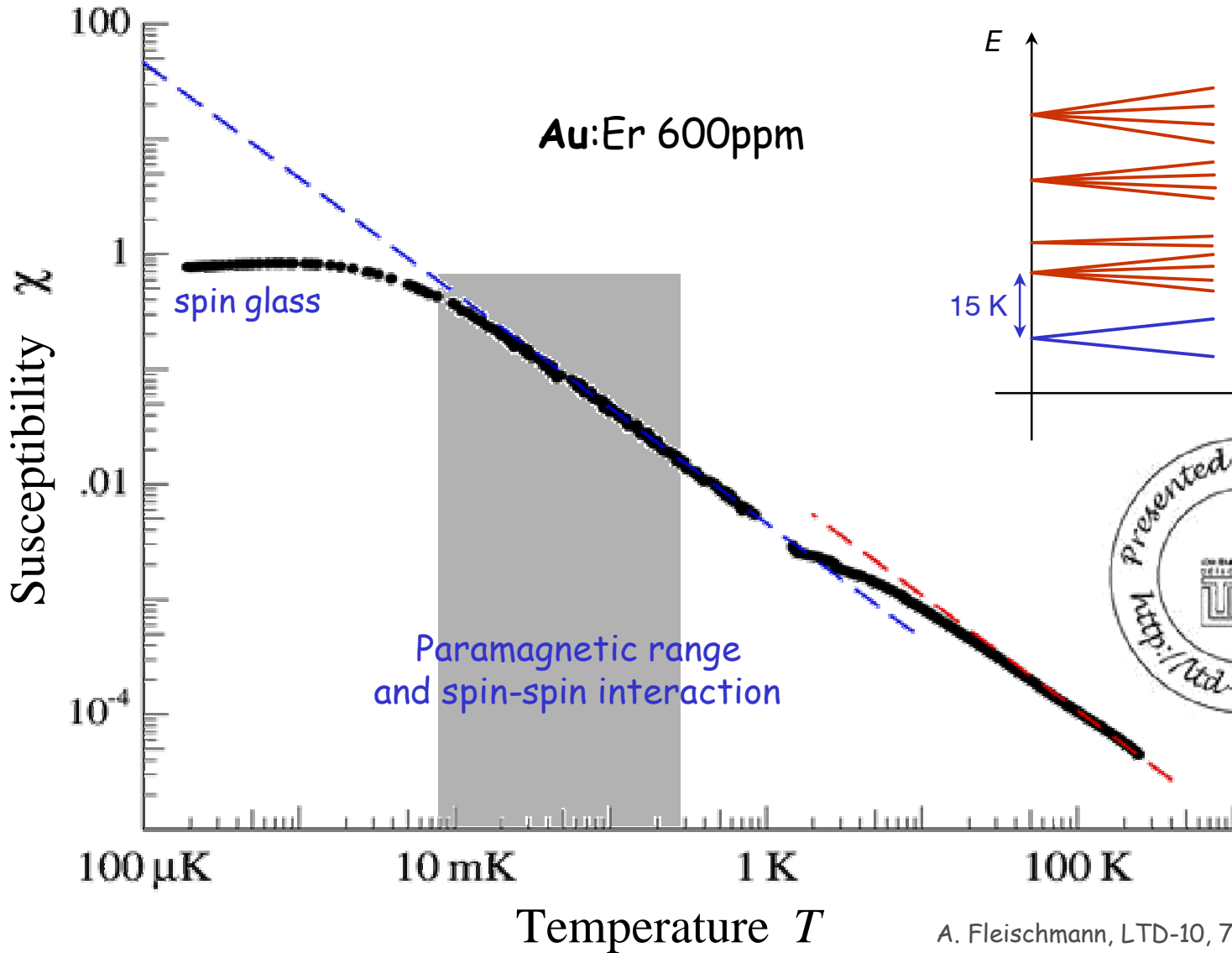

# Calculation of thermodynamic properties

## Interactions:

- magnetic dipole-dipole
- RKKY  
(indirect exchange interaction)

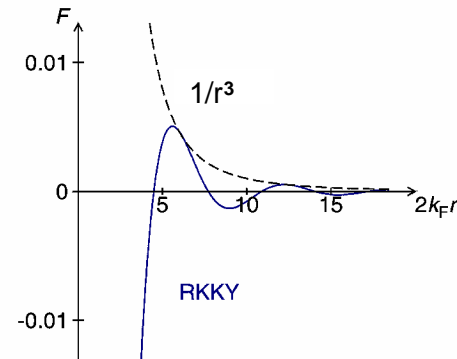

## Numerical simulation:

- 12 spins, randomly distributed
- Hamiltonian matrix
  - ↓ numeric diagonalization
- energy eigenvalues
  - ↓  $M(B,T)$ ,  $C(B,T)$ , 10.000 configs
- $M(B,T)$ ,  $C(B,T)$

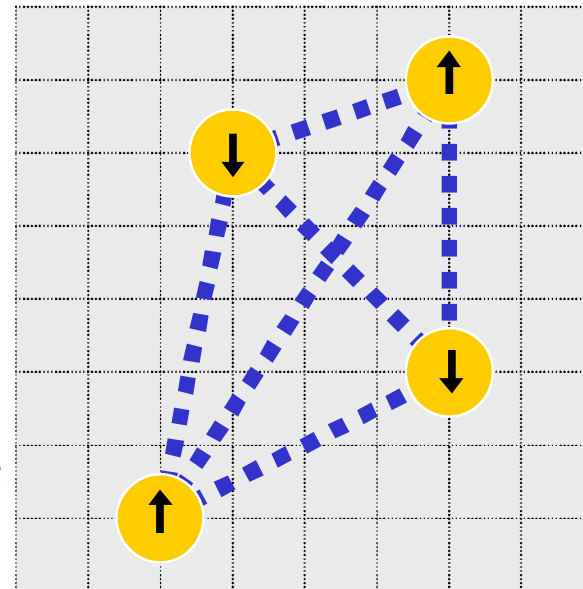

# Magnetization and Heat Capacity

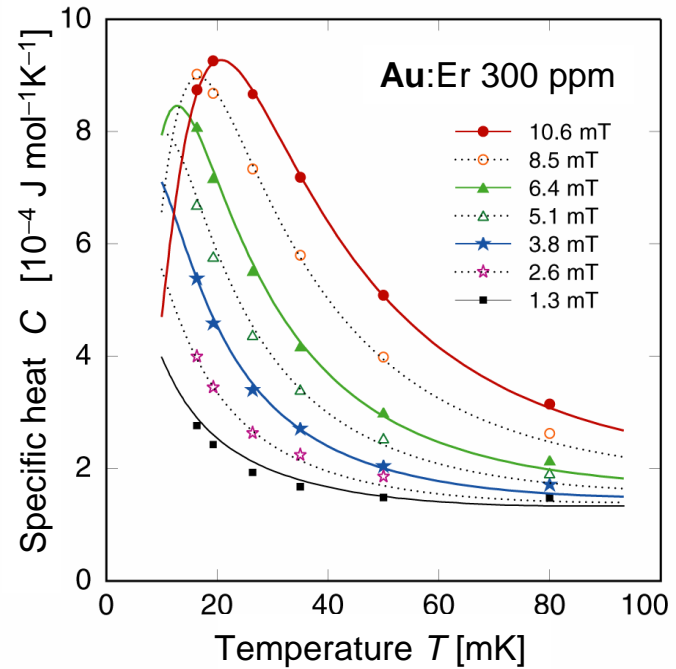
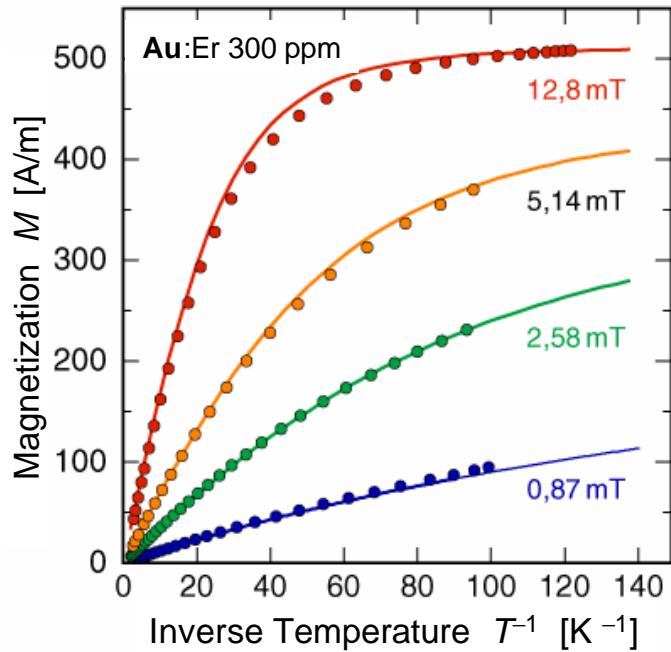

$$\delta \Phi_S \propto \frac{\partial M}{\partial T} \frac{1}{C_{\text{tot}}} \delta E$$

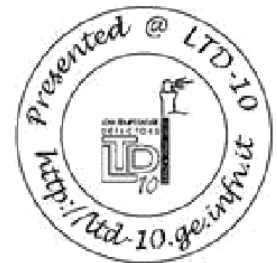

# Calorimeter Signal

$$\delta\Phi_S = f(r, h) \frac{\partial M}{\partial T} \frac{1}{C_{\text{tot}}} \delta E$$

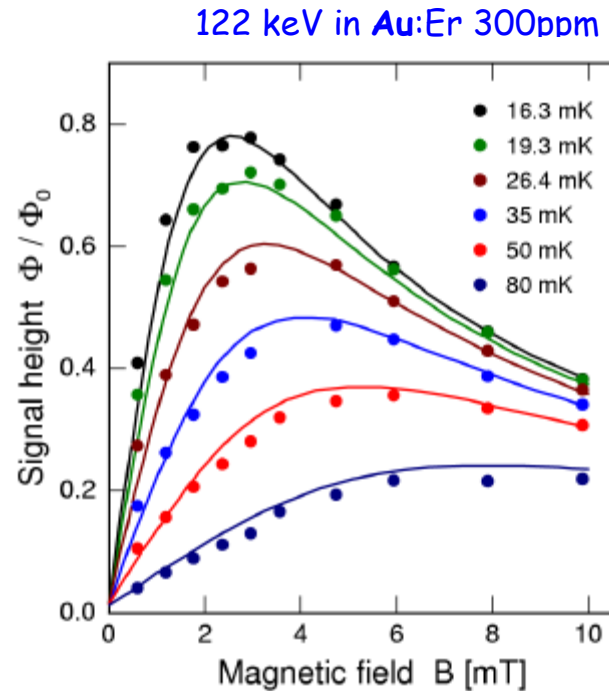
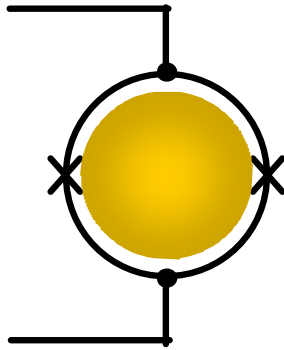

- satisfying agreement of theory and experiment
- signal size can be predicted!
- optimal detector design?

$$S_{\text{max}}(C_a, g, \alpha, T, x, r, h, B)$$

# Optimized Detector Design

- Application requires:
  - Absorber size  $\rightarrow$  heat capacity
  - Operating temperature
- Sensor material (e.g. Au:Er):
  - Landé-factor:  $g$
  - RKKY-interaction:  $a$

## • Optimization of sensitivity

$\rightarrow$  Optimal sensor parameters:

- diameter, thickness
- spin concentration
- magnetic field

## Optimized Sensor:

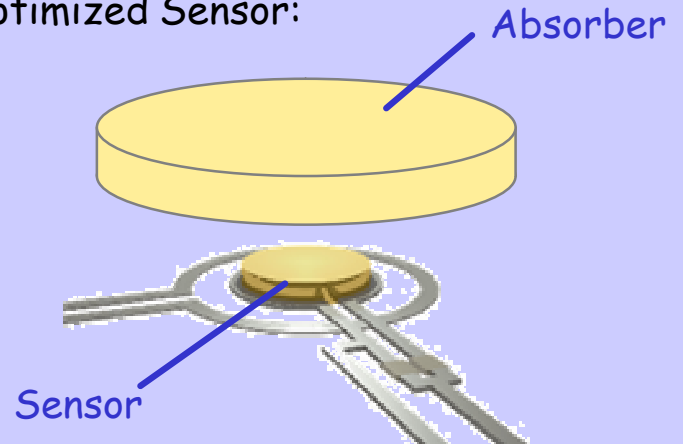

- Sensitivity ( $S = \Delta\Phi/\Delta E$ ):

$$S_{\max} = 1,2 \times 10^{-9} \left( \frac{g}{C_{\text{Abs}} \propto T^2} \right)^{1/3} \frac{\Phi_0}{\text{eV}}$$

$$S_{\max} \propto \frac{1}{T^{2/3}} \quad \text{increases with decreasing } T$$

$$S_{\max} \propto \frac{1}{C_{\text{Abs}}^{1/3}} \quad \text{weakly dependent on absorber heatcapacity}$$



# Alternative Geometries

coupling depends on spin position

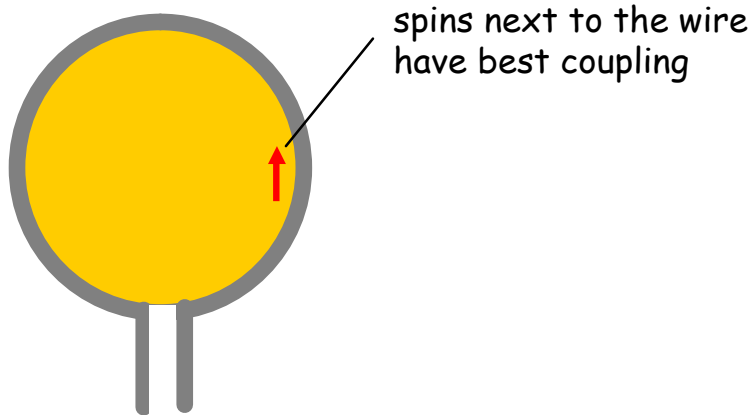

$$S_{\max} \propto \frac{1}{C_{\text{Abs}}^{1/3}}$$

Meanders, multiple loops, miniature coils, ...

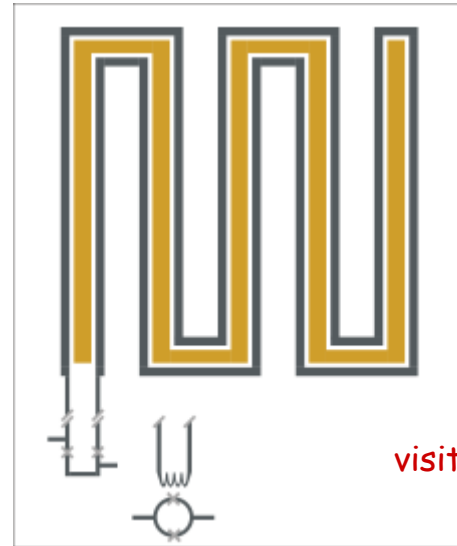

visit Poster A 08

**Sensitivity  $dF/dE$ :**

- almost independent of absorber heat capacity
- roughly proportional to the inverse of structure width

# 2eV X-Ray Detector Pixel



- Temperature: 50mK
- Absorber:  $250 \times 250 \times 5 \mu\text{m}^3$ , gold
  - heat capacity: 1 pJ/K
  - quantum efficiency: > 98% (6keV)

- ➔ • Sensor:
  - Au:Er 900ppm,  $\varnothing$  52 $\mu\text{m}$ ,  $h=6.5\mu\text{m}$
- Sensitivitat:
  - 0,12  $\Phi_0$  / keV
- Relaxation times:
  - rise: <  $10^{-6}\text{s}$
  - decay:  $10^{-3}\text{s}$

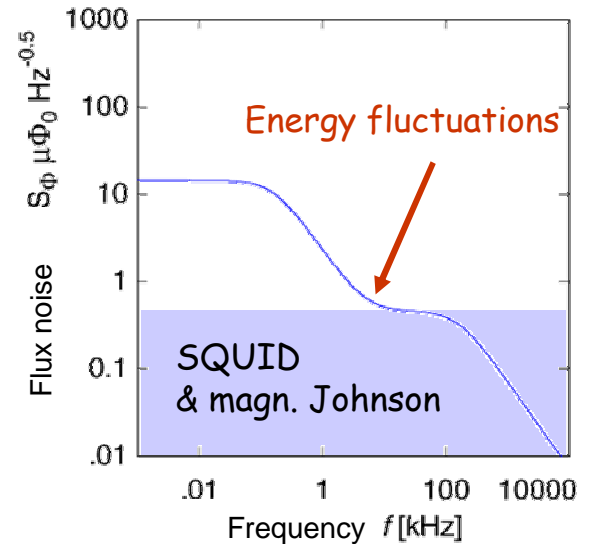

- ➔ • Energy resolution:  $\Delta E_{\text{FWHM}} \cong 1.4 \text{ eV}$

SQUID noise  
and Johnson noise:  
20% increase

# Two-Stage SQUID Magnetometer

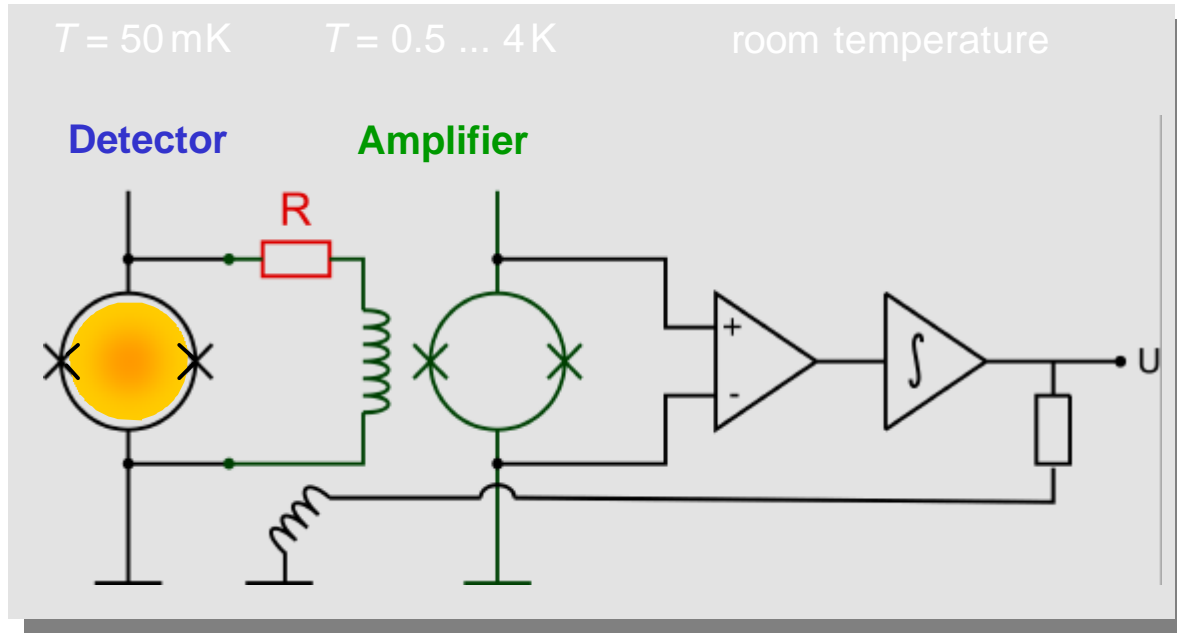

- Detector SQUID read out by a **current-sensor** SQUID
- **Two-stage setup** allows for:
  - **Low noise**
  - **Large bandwidth** / Slewrate
  - **Small power dissipation** on detector SQUID chip (Voltage bias)



# Two-Pixel Detector

## SQUID Gradiometer With Two Sensors

two Au:Er 300 ppm sensors

$\varnothing$  50  $\mu\text{m}$ ,  $h = 25 \mu\text{m}$

magnetic field 3 mT

two gold absorbers:  $160 \times 160 \times 5 \mu\text{m}^3$

Detector SQUID:

commercial SQUID chip  
M.B. Ketchen, IBM 1992

Amplifier SQUID: IPHT-Jena

SQUID-Electronics (IPHT-Jena):

voltage noise:  $0.3 \text{ nV}/\sqrt{\text{Hz}}$   
very low temperature dependence

ADR: VeriCold Technologies, Munich

21 mK base temperature, holdtime below 30 mK: 2 days

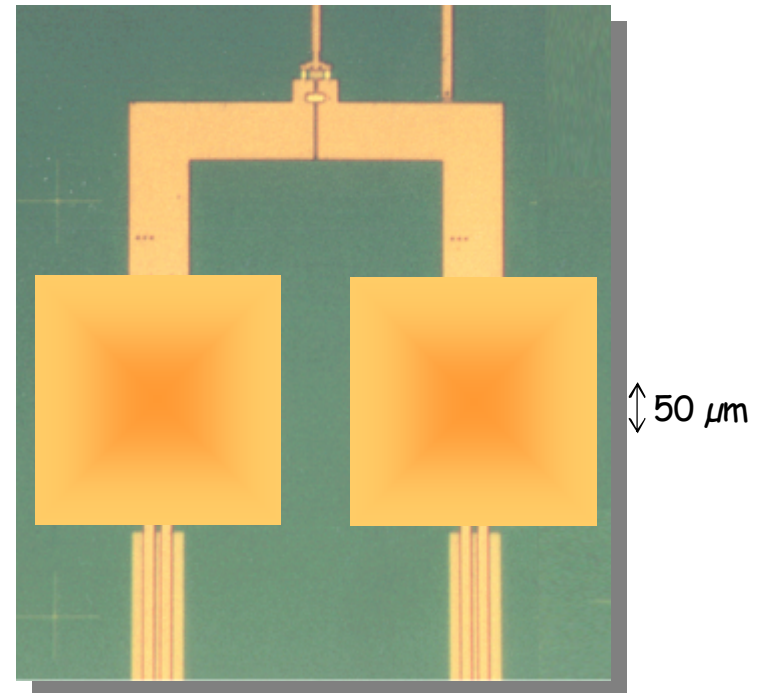

# Two-Pixel Detector

X-rays from  $^{55}\text{Fe}$ -Source:

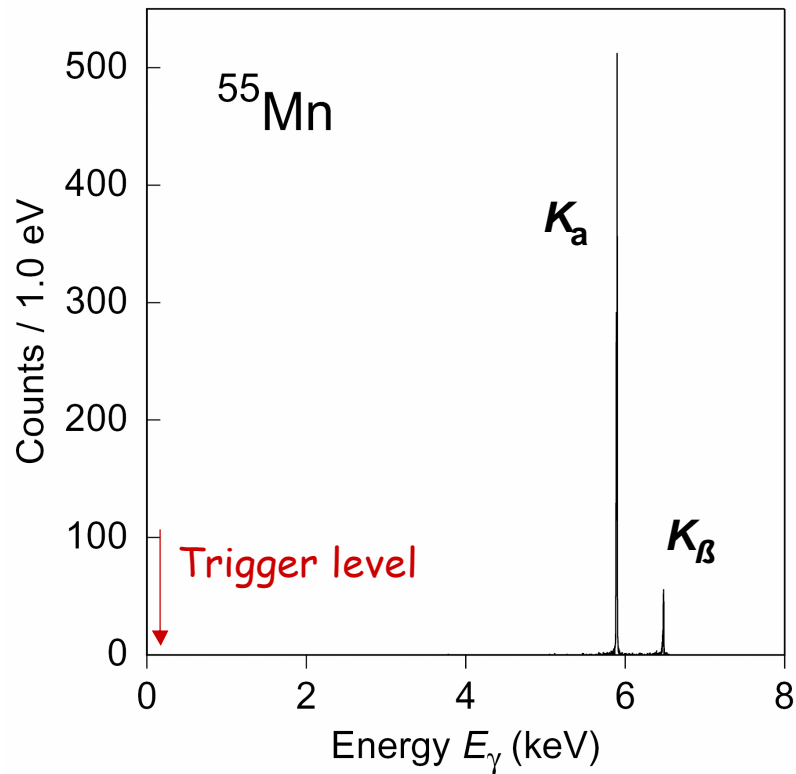

➔ clean spectrum

# Two-Pixel Detector

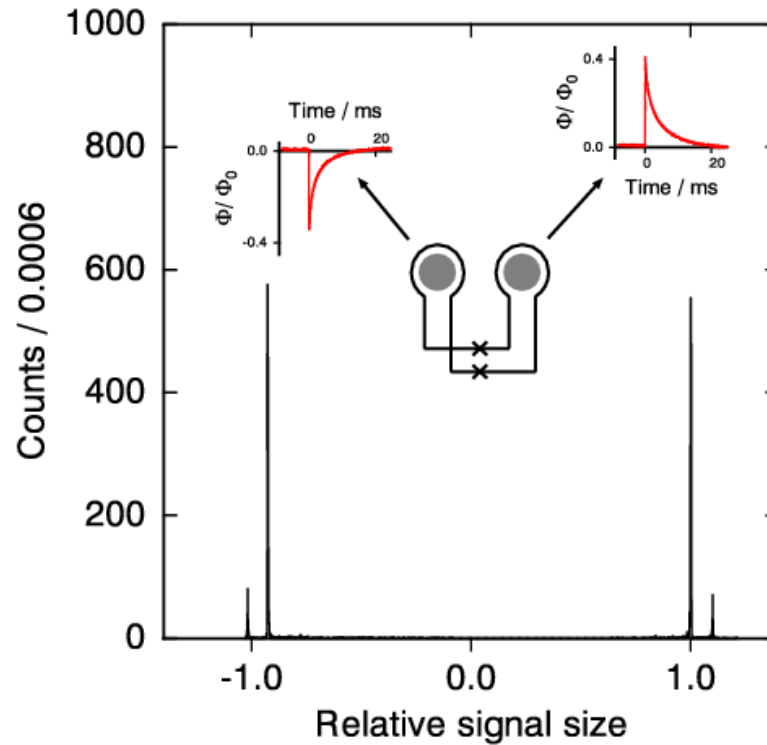

performance of pixels  
almost identical

# Resolution: $K_{\alpha}$ -Line $^{55}\text{Mn}$

Two Au:Er 300 ppm sensors

Two Gold absorbers:  $160 \times 160 \times 5 \mu\text{m}^3$

Total heatcapacity: 2.5 pJ/K

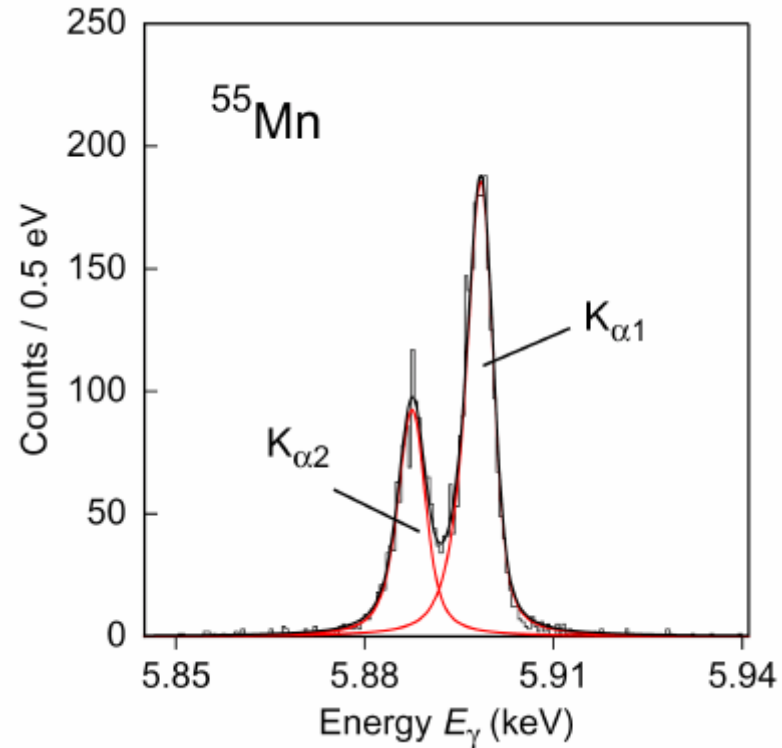
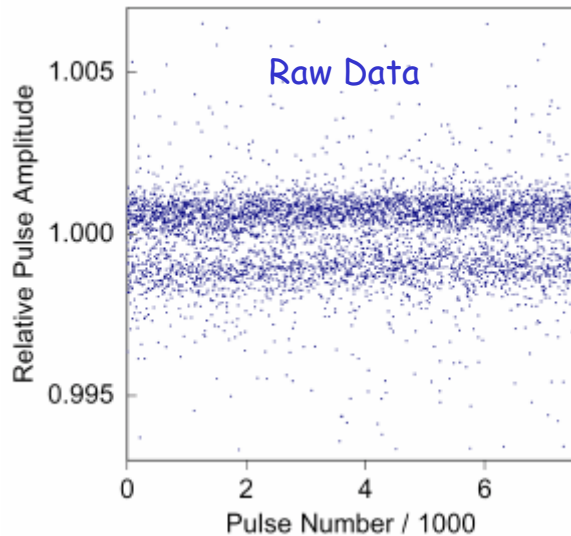

energy resolution 3.4 eV

resolving power > 1700

# Resolution: $K_{\beta}$ -Line $^{55}\text{Mn}$

Two Au:Er 300 ppm sensors

Two Gold absorbers:  $160 \times 160 \times 5 \mu\text{m}^3$

Total heatcapacity: 2.5 pJ/K

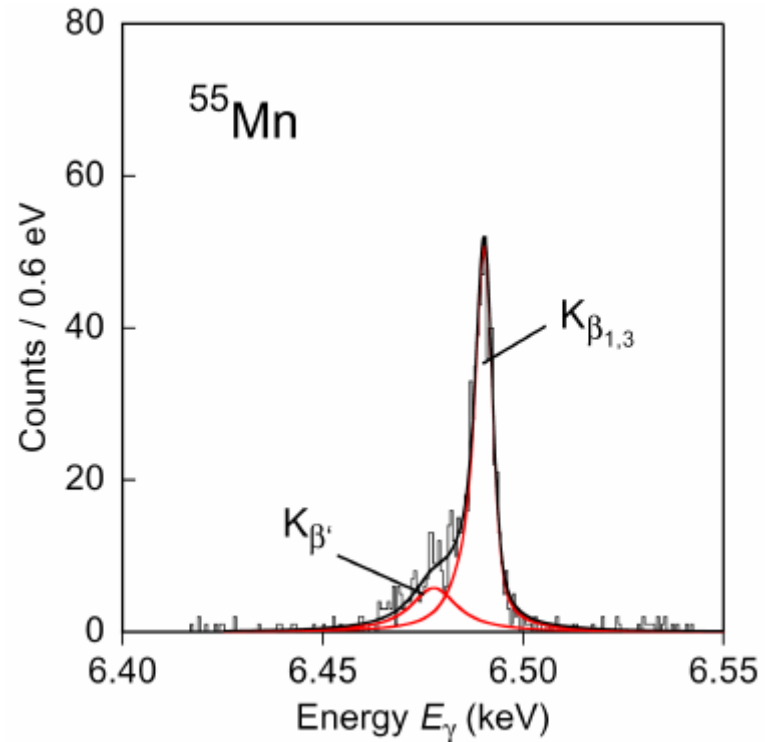
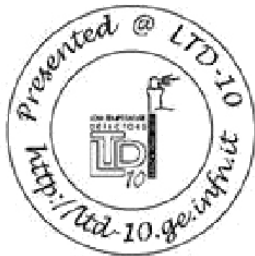

energy resolution 3.4 eV



# Baseline Noise

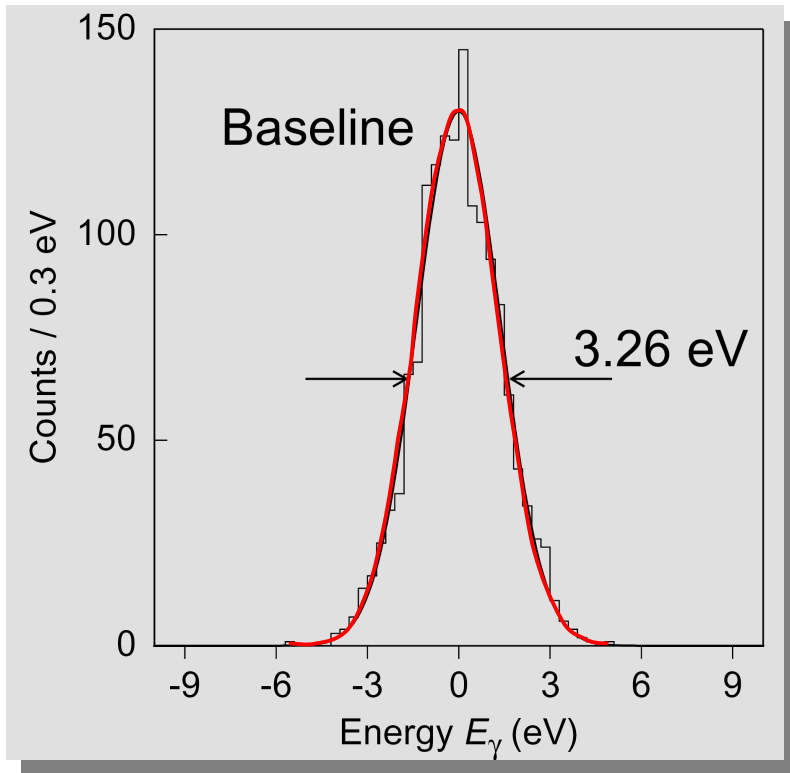

Resolution is ,constant'  
over the whole energy range  
Small temperature drifts  
Small position dependence

# Noise Spectrum at 33 mK

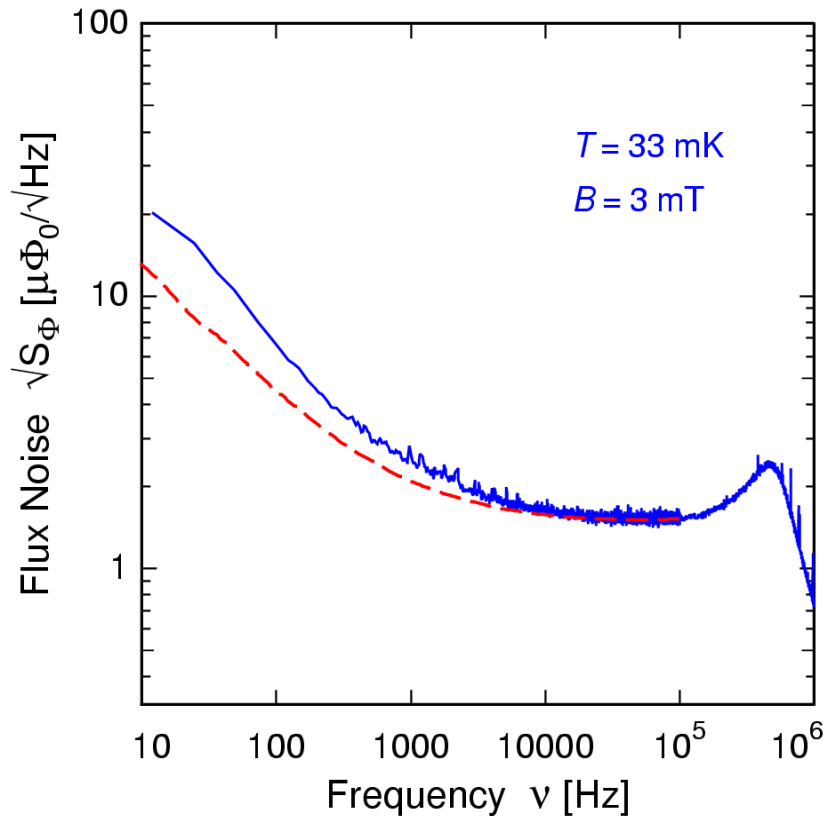

Noise at low frequencies:  
about 2 times larger  
than expected from  
thermodynamic energy fluctuations

# 1/f - Noise

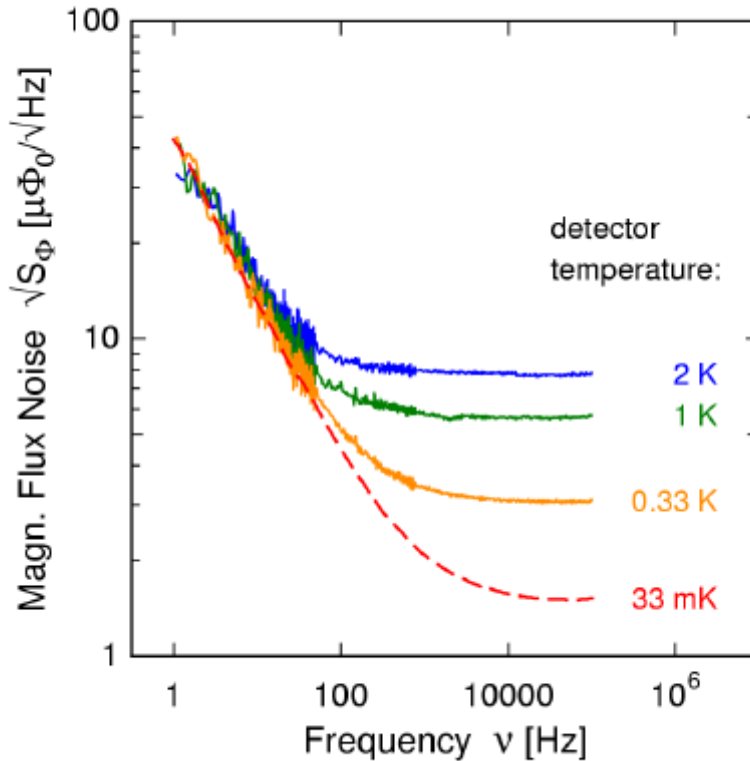

## Observations:

temperature **independent**  
(30 mK ... 4 K)

magnetic field **independent**  
(0 ... 35 G)

concentration dependence ?

volume dependence ?

Contribution to the energy resolution:  
**2 eV**



# Thermalization

Sensor bonded with vacuum grease to Si

Heat capacity  $1.2 \times 10^{-12}$  J/K

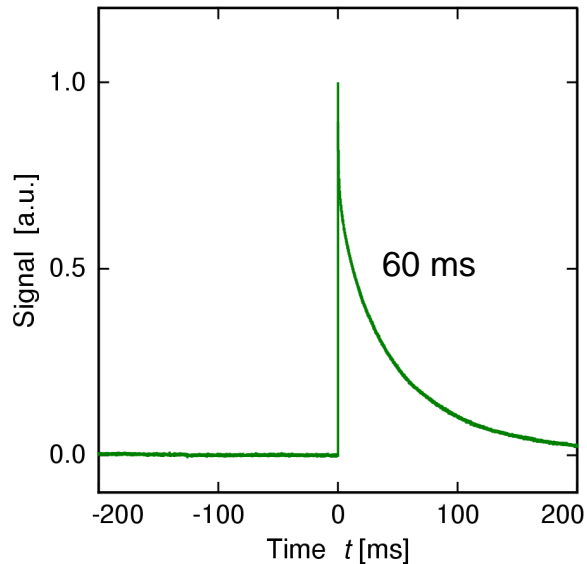

Sensor: 1000x larger,  
spot-welded to copper block

Heat capacity  $10^{-9}$  J/K

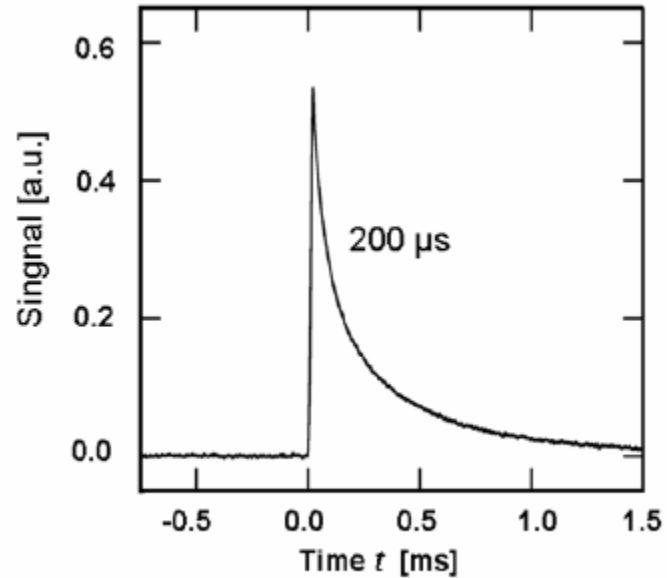

- magnetic calorimeters can be made very fast
- Plan: microstructured thin film on the SQUID-chip for thermalization

# Applications

---

Industrial :

material analysis  
absolute activity measurement

Astrophysics:

solar neutrino detection  
x-ray astronomy  
dark matter detection

Nuclear physics:

gamma-ray detection  
beta decay  
double-beta decay



# Material Analysis

## X-ray fluorescence analysis

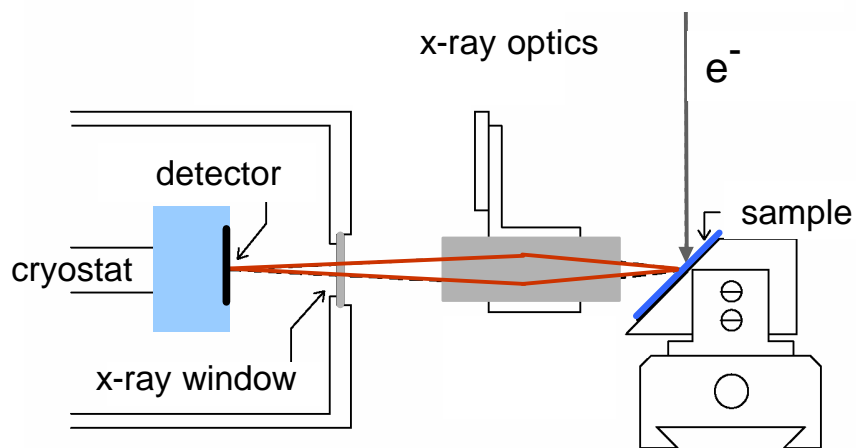

long term goal is: resolution  $2 \text{ eV at } 6 \text{ keV,}$   
count rate  $100/\text{s,}$   
quantum efficiency  $99\% \text{ up to } 6 \text{ keV}$   
operated in a **cryo-liquid free cryostat**



# MMCs for Metrology

## Goal:

Measurement of absolute source activity

## Challenge:

99.99% quantum efficiency

4 $\pi$ -geometry

large dynamic range

details on Poster N  
04, (M. Loidl, et al.)



COMMISSARIAT À L'ÉNERGIE ATOMIQUE

## Example $^{55}\text{Fe}$

4 $\pi$ -Sandwich:

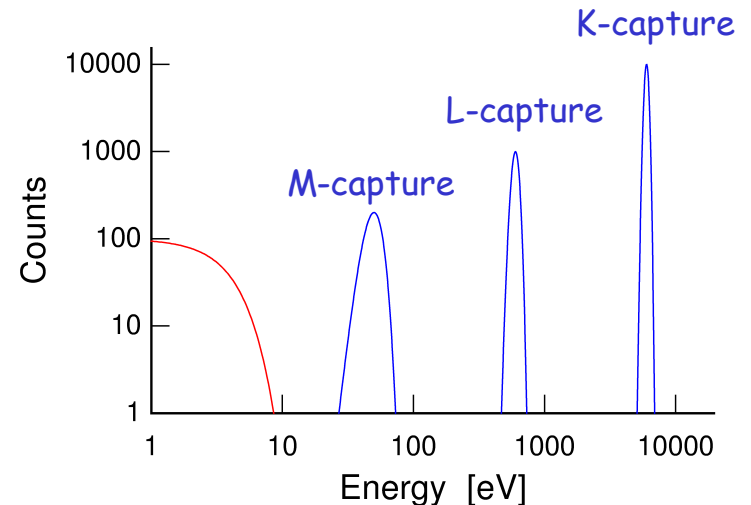
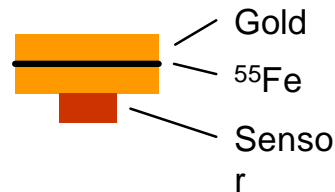

# Recent Result

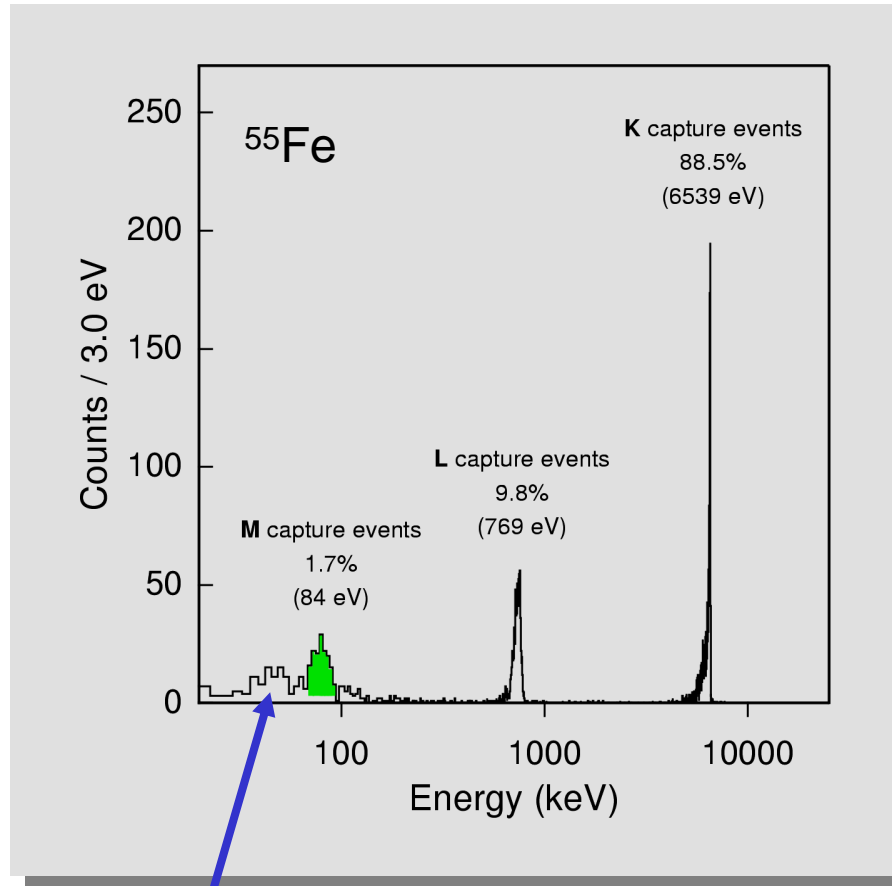

Low energy background

→ shielding & higher activity





# Summary

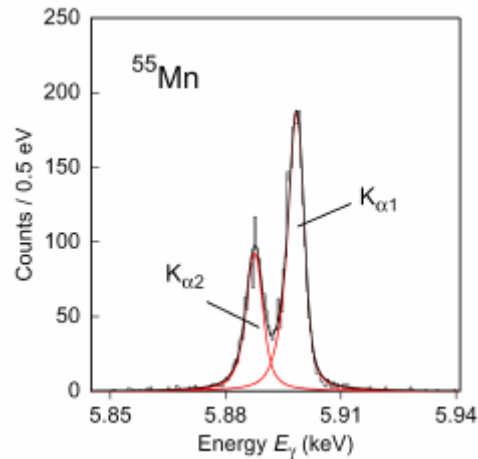

- MMCs can be used for  
high resolution x-ray spectroscopy
- MMCs are a promising detector concept  
especially for applications which  
require high heat capacities

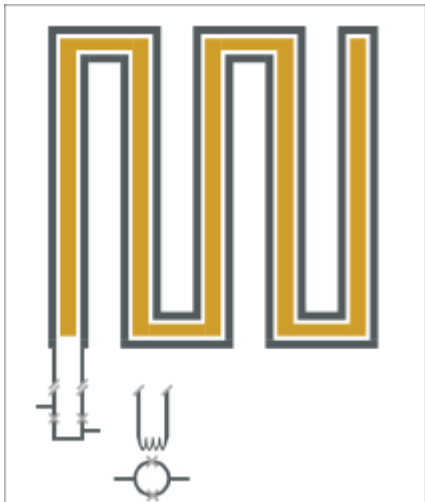

- There are lots of things to be looked at
- Hopefully more groups will join this effort ... ?

